

# **BONALDO**

## Flame, Flame Wood

Designer: Gino Carollo



Flame's main features are its harmonious shapes and light, sinuous volumes. The top, which is visibly suspended, is fully usable thanks to the position of the double base designed to optimize the overall space. Form and function are perfectly expressed in this table: the extensive customization options allow you to arrange it according to your tastes, needs and the mood of the surrounding space. The top is available in a number of sophisticated finishes – from wood to ceramic and marble – and you can choose from various metal options for the base. A wooden base is also available for this modern living room table (Flame Wood).



# Data sheet

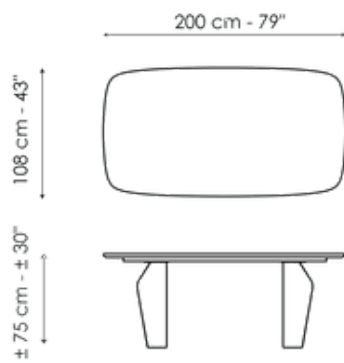

Width: 200cm  
Depth: 108cm  
Height: ± 75cm

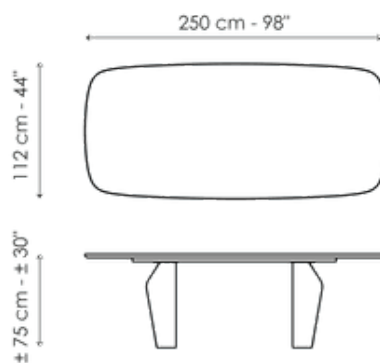

Width: 250cm  
Depth: 112cm  
Height: ± 75cm

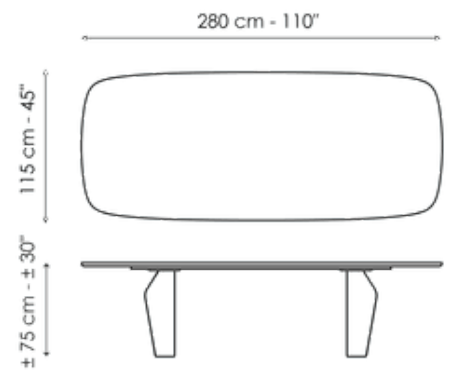

Width: 280cm  
Depth: 115cm  
Height: ± 75cm

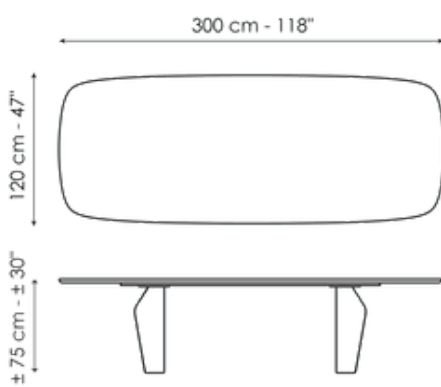

Width: 300cm  
Depth: 120cm  
Height: ± 75cm

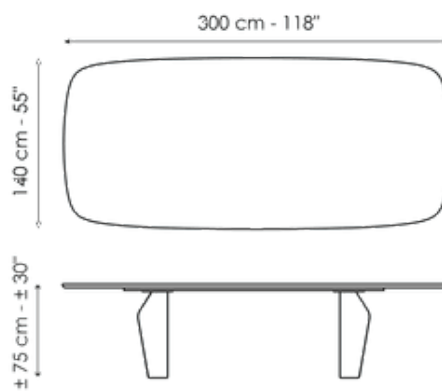

Width: 300cm  
Depth: 140cm  
Height: ± 75cm

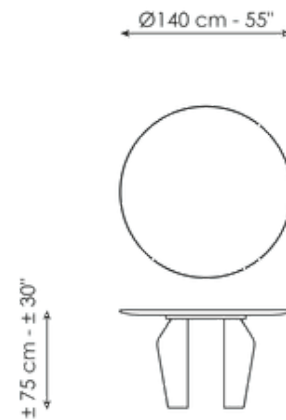

Width: 140cm  
Depth: 140cm  
Height: ± 75cm

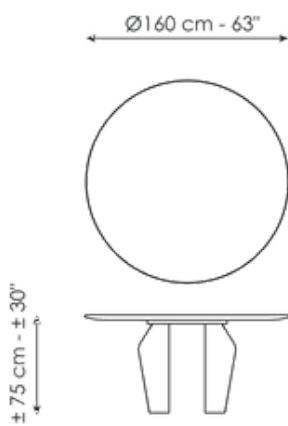

Width: 160cm  
Depth: 160cm  
Height: ± 75cm

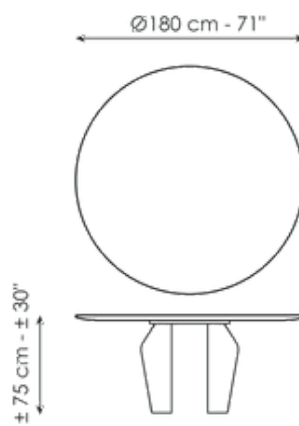

Width: 180cm  
Depth: 180cm  
Height: ± 75cm

# Finishes

## Barrel-shaped top

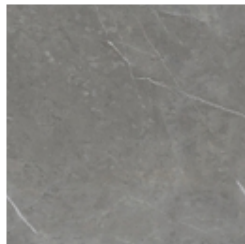

**Mat ceramic**  
Ardesia grey



**Glossy ceramic**  
Calacatta



**Silk finish ceramic**  
Calacatta macchia vecchia

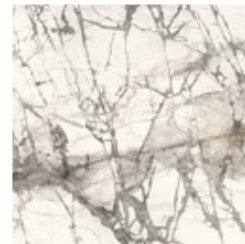

**Glossy ceramic**  
Imperial grey

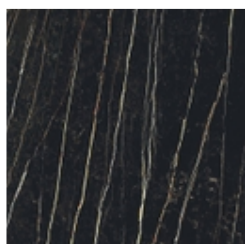

**Mat ceramic**  
Laurent

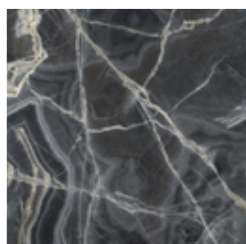

**Glossy ceramic**  
Black Onyx

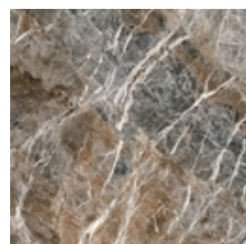

**Glossy ceramic**  
Mountain peak

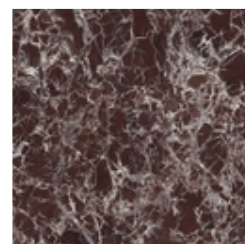

**Glossy ceramic**  
Rosso imperiale



**Mat ceramic**  
Augusta

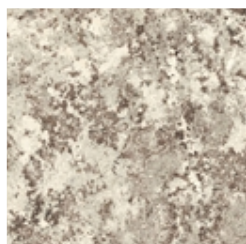

**Mat ceramic**  
Alaska White

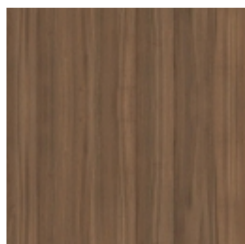

**Veneered wood**  
Walnut Canaletto



**Solid wood**  
Brushed coal oak



**Solid wood**  
Brushed natural oak

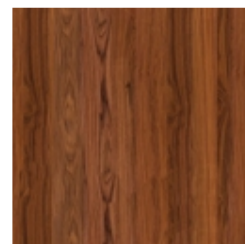

**Solid wood**  
American walnut

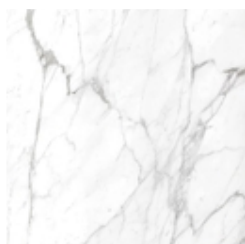

**Marble**  
Calacatta

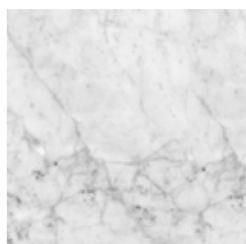

**Marble**  
Carrara

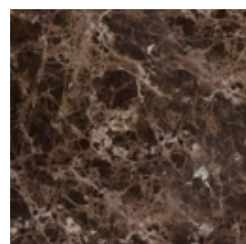

**Marble**  
Emperador

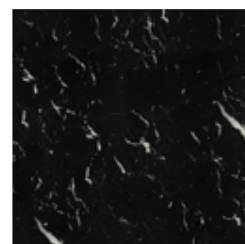

**Marble**  
Marquinia

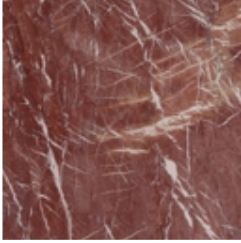

**Marble**  
Rosso Carpazi

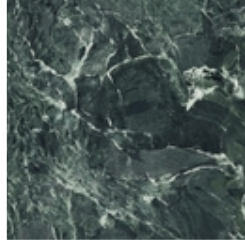

**Marble**  
Saint Denis



**Marble**  
Fior di bosco

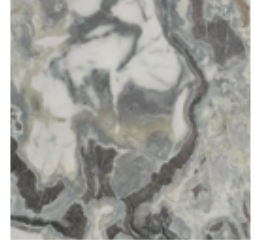

**Marble**  
Dover White



**Marble**  
Travertino Romano

---

## Round top



**Marble**  
Calacatta

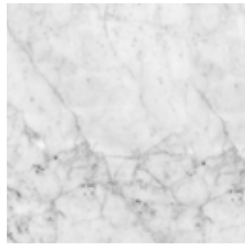

**Marble**  
Carrara

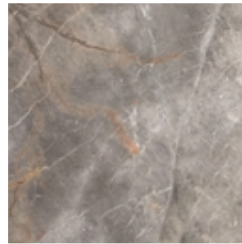

**Marble**  
Fior di bosco

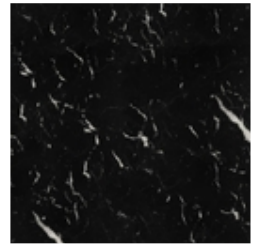

**Marble**  
Marquinia



**Marble**  
Rosso Carpazi

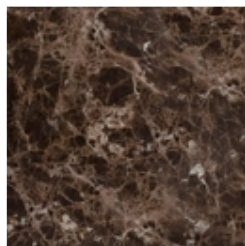

**Marble**  
Emperador

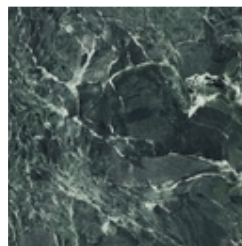

**Marble**  
Saint Denis



**Marble**  
Travertino Romano

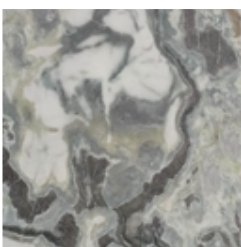

**Marble**  
Dover White

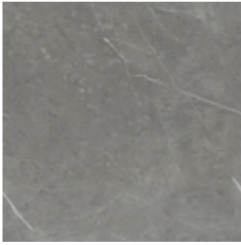

**Mat ceramic**  
Ardesia grey

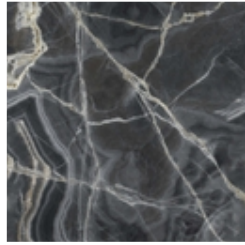

**Glossy ceramic**  
Black Onyx



**Glossy ceramic**  
Calacatta



**Silk finish ceramic**  
Calacatta macchia vecchia

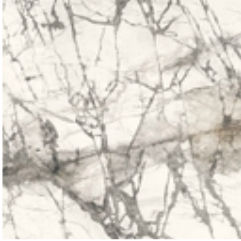

**Glossy ceramic**  
Imperial grey

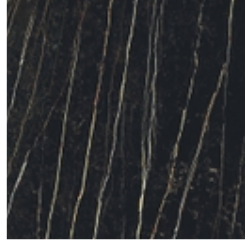

**Mat ceramic**  
Laurent

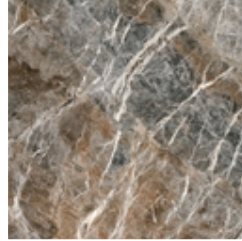

**Glossy ceramic**  
Mountain peak

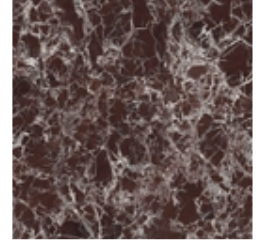

**Glossy ceramic**  
Rosso imperiale

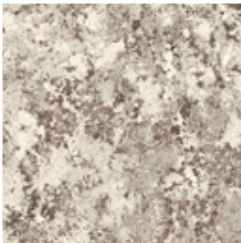

**Mat ceramic**  
Alaska White



**Mat ceramic**  
Augusta

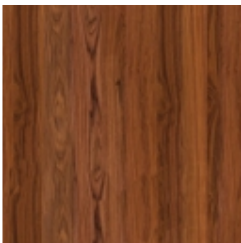

**Solid wood**  
American walnut



**Solid wood**  
Brushed coal oak



**Solid wood**  
Brushed natural ash

---

## Base

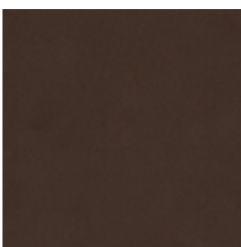

**Painted metal**  
Mat bronze

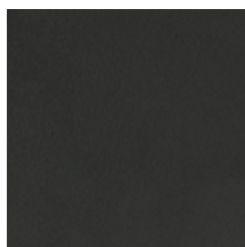

**Painted metal**  
Mat lead



**Painted metal**  
Mat pearl gold



**Painted metal**  
Mat brass



**Painted metal**  
Mat copper

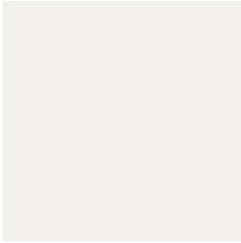

**Painted metal**  
Mat white



**Painted metal**  
Mat brown



**Painted metal**  
Mat black

**Painted metal**  
Supreme anthracite



**Painted metal**  
Mat dove grey

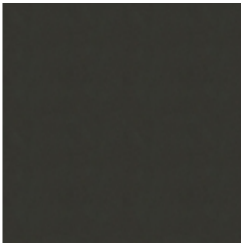

**Metal finish**  
Burnished



**Metal finish**  
Brown nickel



**Metal finish**  
Dark nickel



**Metal finish**  
Clouded chrome

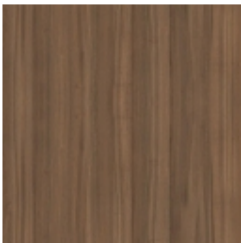

**Veneered wood**  
Walnut Canaletto



**Veneered wood**  
Coal oak